



EBARA



SQPB-8001-V

SELF PRIMING PUMP

MODEL SQPB



APPLICATIONS



Irrigation



Drainage



Sprinklers

FEATURES

1. No priming is required excepting for initial use.
2. Special designed casing provides very rapid priming for extended piping
3. Maintenance is facilitated due to packing type.
4. Water mixed with a little sand or mud can be pumped up due to semi - open impeller design.
5. Easy installation with engine for belt driven due to c.c.w rotation.

SPECIFICATION MODEL SQPB

DISCRIPTION	STANDARD	OPTION
Liquid	Fresh water, river water rain water	sea water
Temperature	0-40°C	
Reg.NPSH	4 m	
Rotation	Counter clockwise when viewed from drive end	
Installation	Outdoors	
Material Casing Impeller Shaft	Cast iron Cast iron Carbon steel	Bronze Bronze Stainless steel
Constraction Impeller Stuffing box Bearing	Semi open Packing Sealed ball bearing	
Accessories	Strainer, Discharge elbow Hose clamp, Suction hose nipple Standard V - pulley	

SELECTION OF THE PUMP CALCULATION FOR PADDY FIELD

Water Consumption of paddy field is 60 l/min/Ha

Example : Paddy field : 5 Ha

what is the model of pump

Pump head: 10 m

Result : water consumption (Q) : 5 Ha x 60 l/min/Ha
: 300 l/min = 0.3 m³/min

The pump model is 50 SQPB

SECTIONAL VIEW

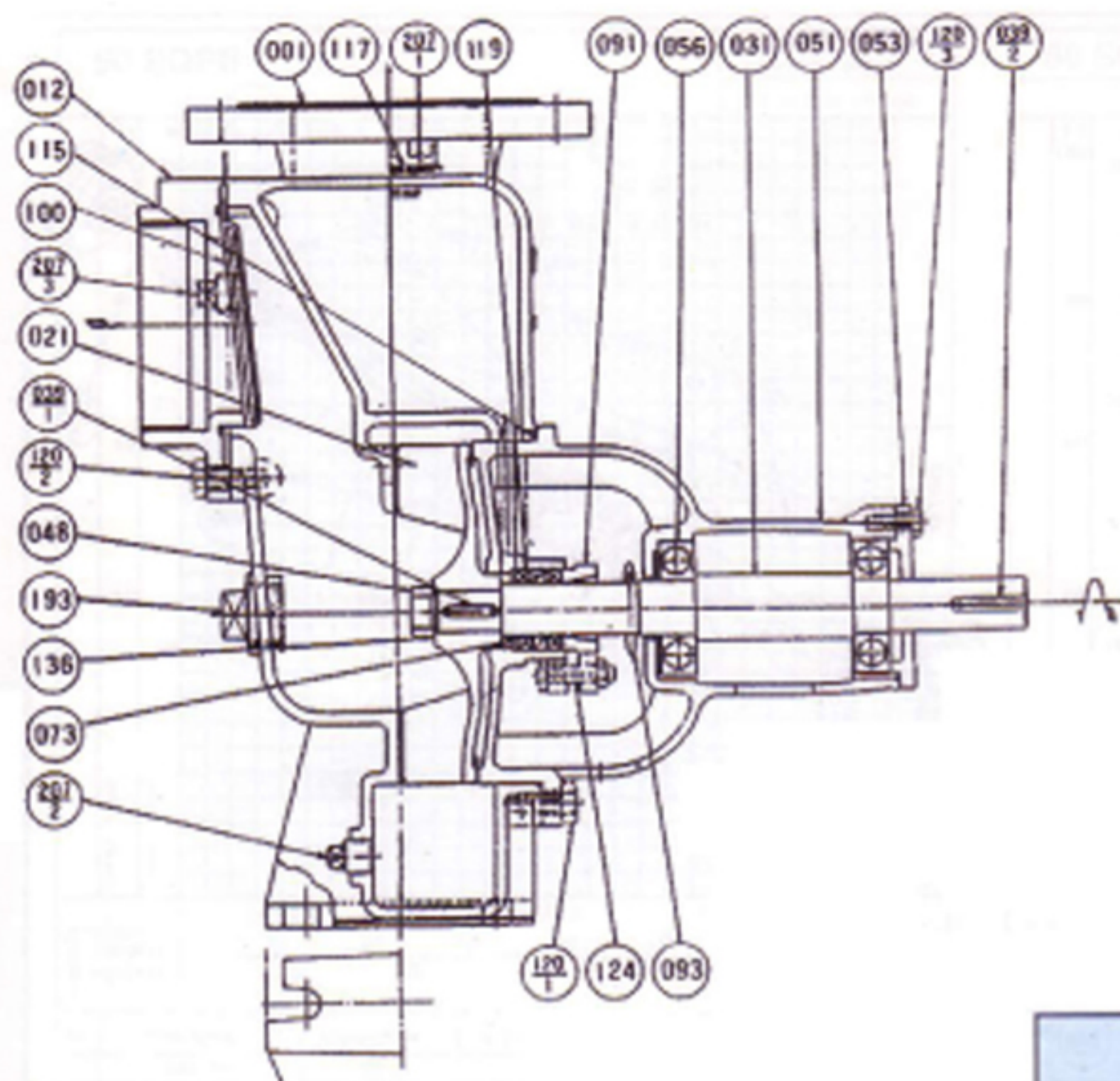

207 - 3	PLUG	CAST IRON	1
207 - 2	DRAIN PLUG	CAST IRON	1
207 - 1	PRIMING PLUG	PLASTIC	1
193	PLUG	CAST IRON	2
136	WASHER	BRASS	1
124	GLAND BOLT AND NUT	STEEL	1
120 - 3	BOLT	STEEL	2
120 - 2	SUCTION COVER BOLT	STEEL	3
120 - 1	CASING BOLT	STEEL	4
119	GLAND PACKING	ASBESTOS	3
117	GASKET	RUBBER	1
115	O-RING	NBR	1
100	CHECK VALVE	RUBBER	1
093	DEFLECTOR	NBR	1
091	GLAND	CAST IRON	1
073	STAGE PIECE	STEEL	1
056	BALL BEARING	-	2
053	BEARING COVER	CAST IRON	1
051	BEARING HOUSING	CAST IRON	1
048	IMPELLER NUT	BRASS	1
039 - 2	KEY	CARBON STEEL	1
039 - 1	KEY	CARBON STEEL	1
031	SHAFT	CARBON STEEL	1
021	IMPELLER	CAST IRON	1
012	SUCTION COVER	CAST IRON	1
001	CASING	CAST IRON	1
PART NO	PART NAME	MATERIAL	NO. FOR 1 UNIT



SEMI OPEN IMPELLER

OTHER

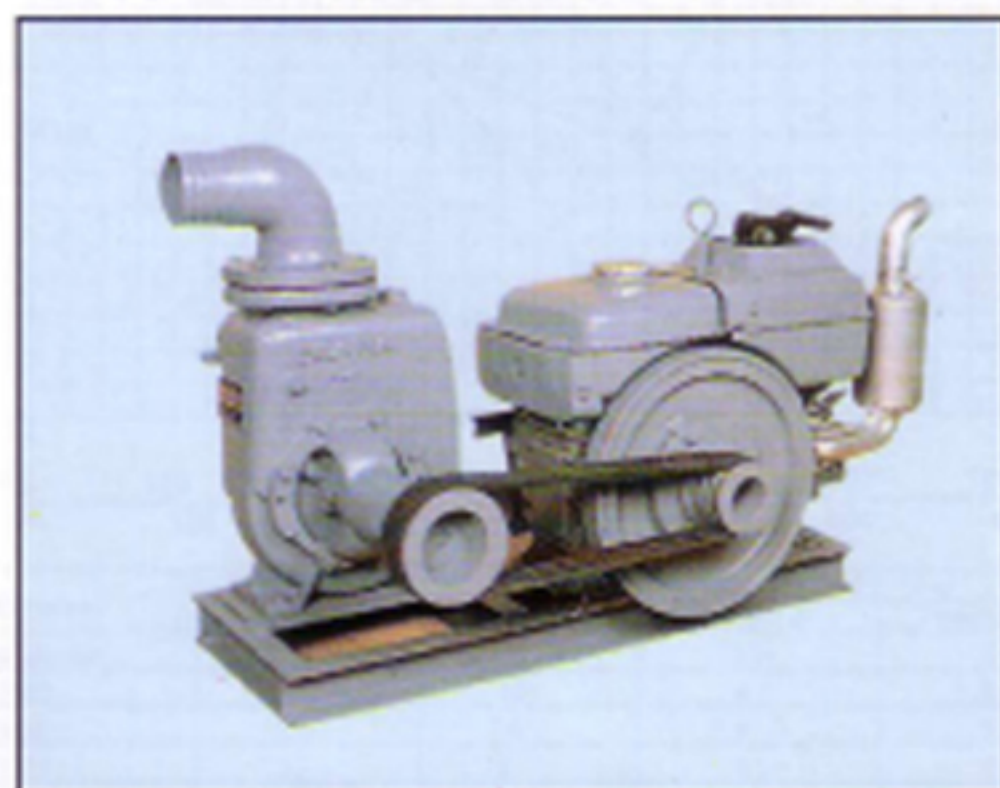

PUMP COUPLED WITH ENGINE

* This picture doesn't show belt cover.
for safety belt cover should be install.

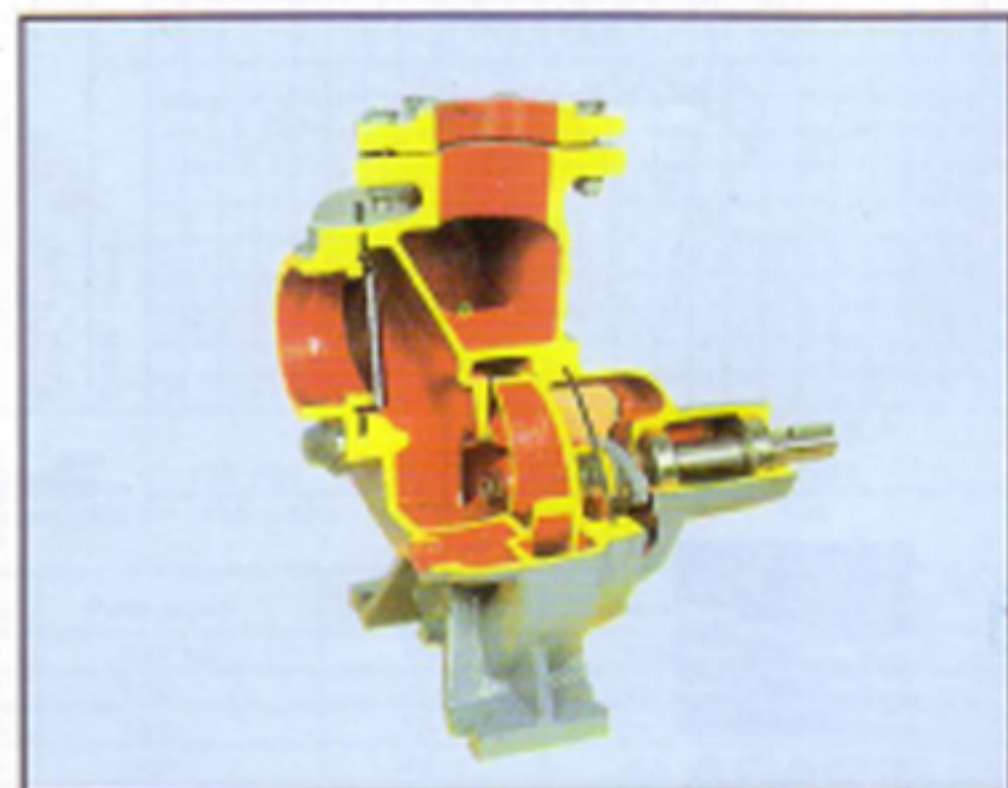

CUT MODEL

PERFORMANCE CURVE

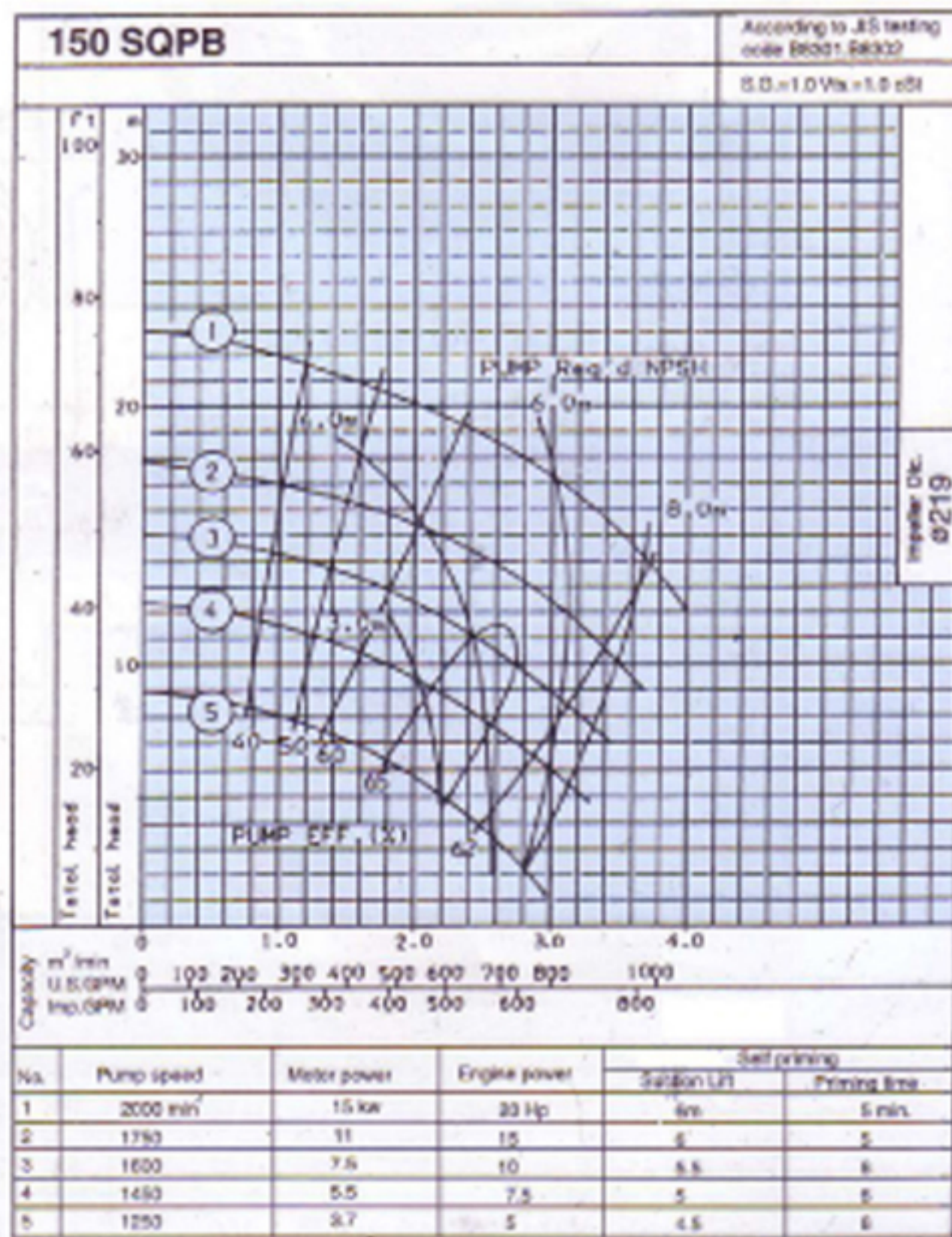
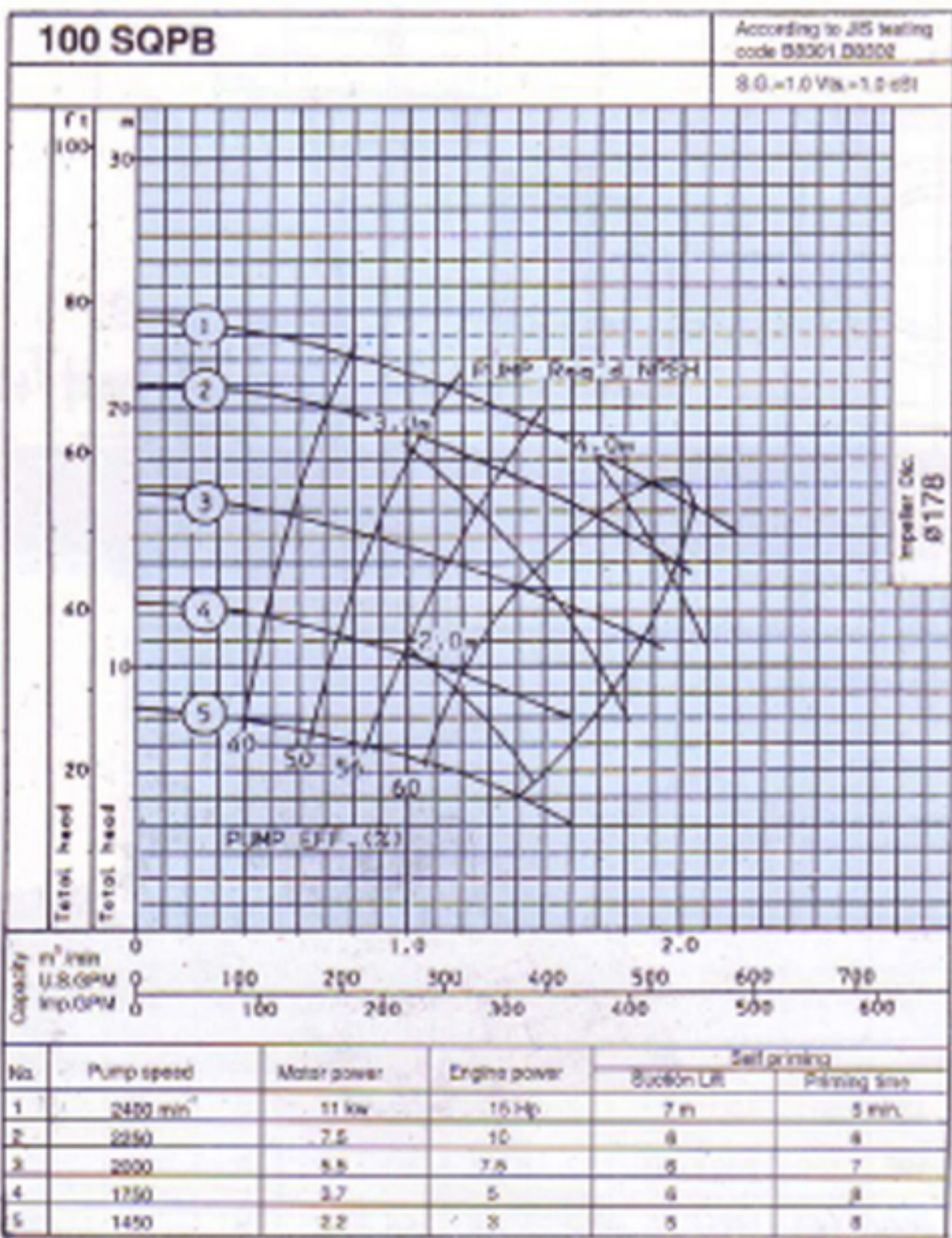
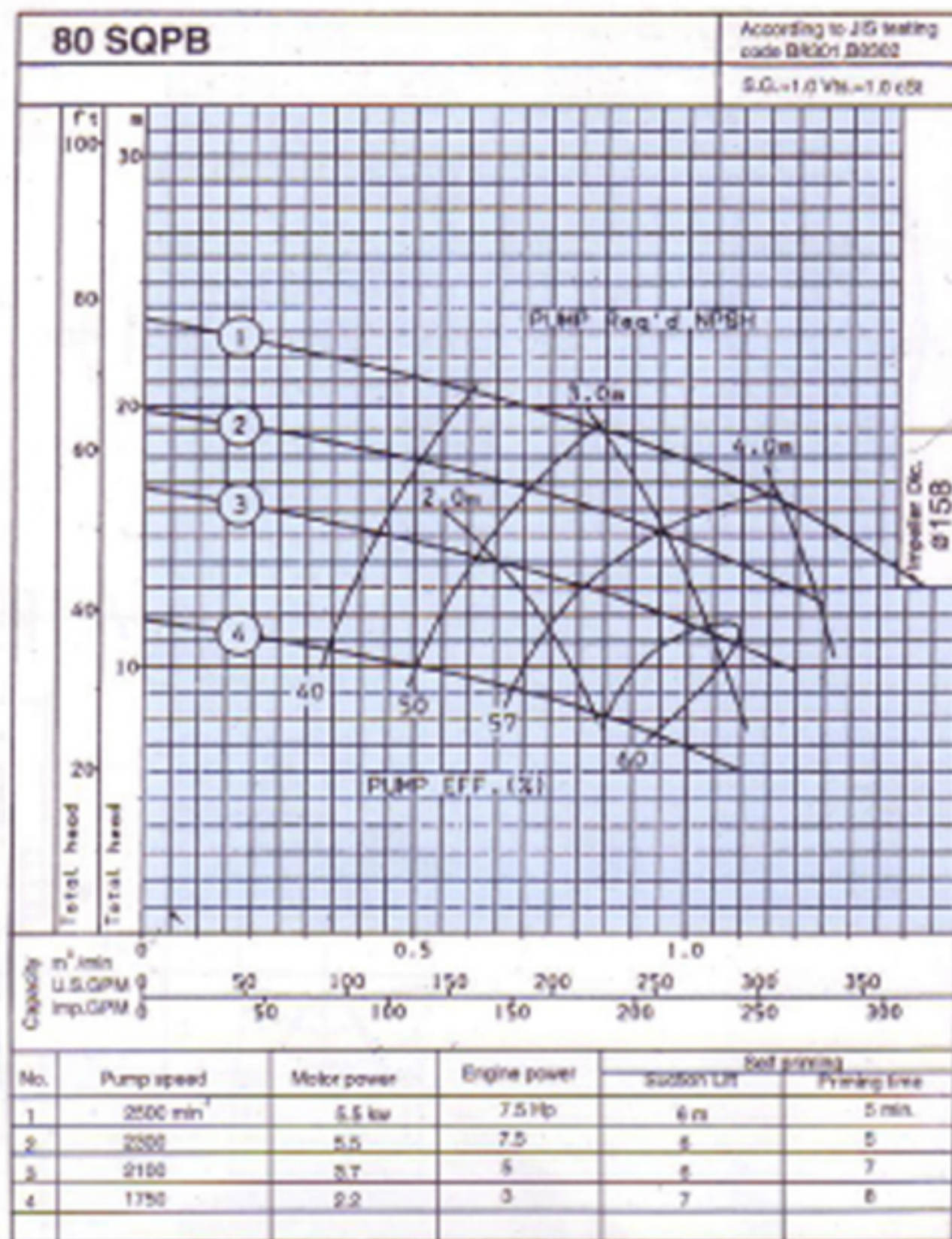
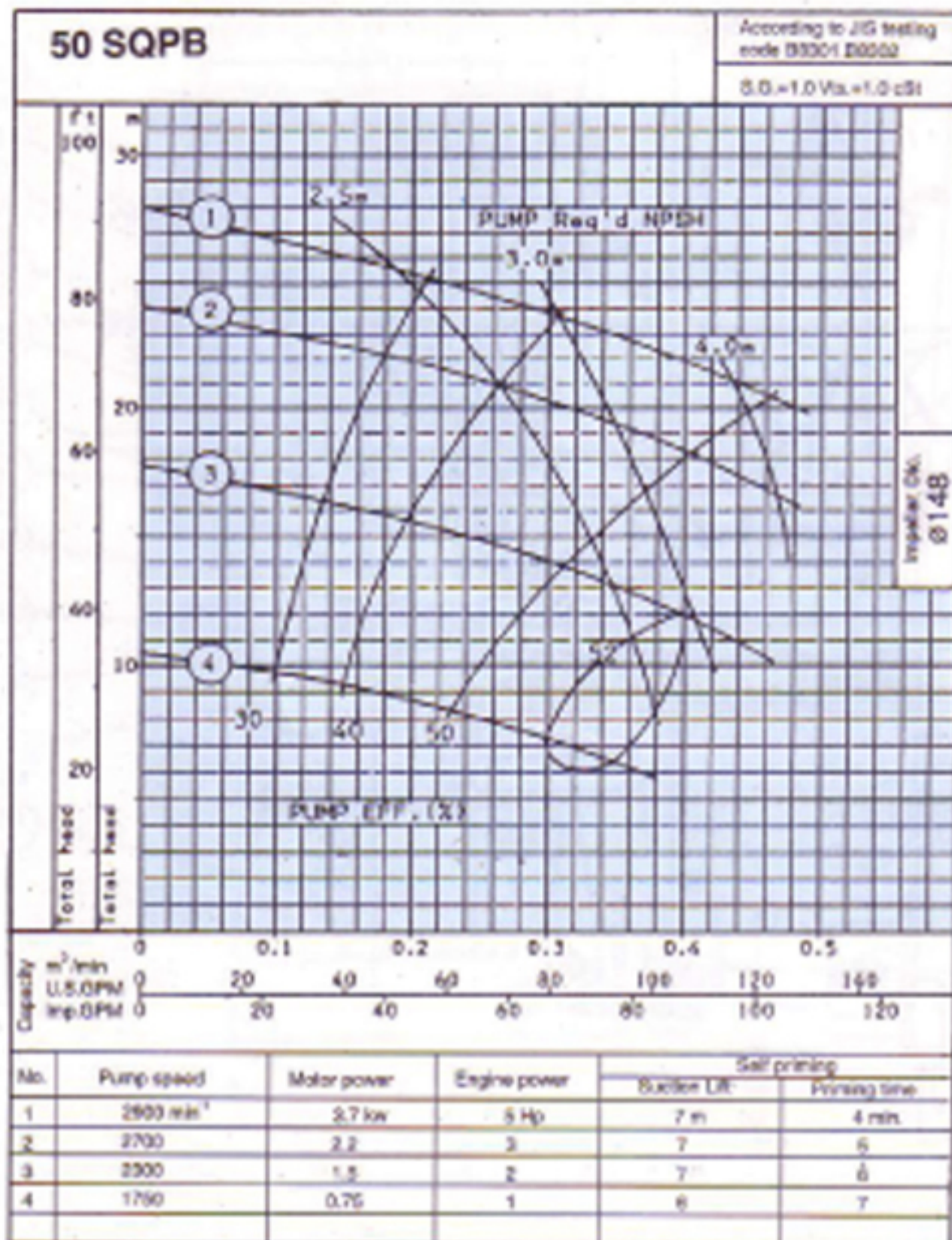

BARE SHAFT PUMP DIMENSIONS

50 SQPB

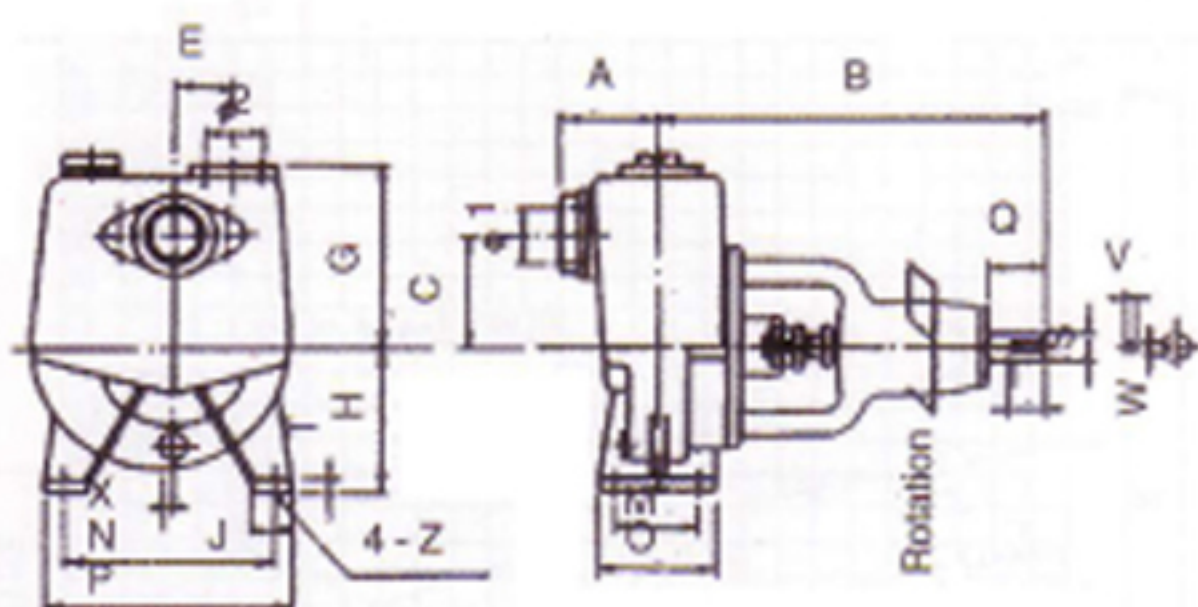

80 SQPB

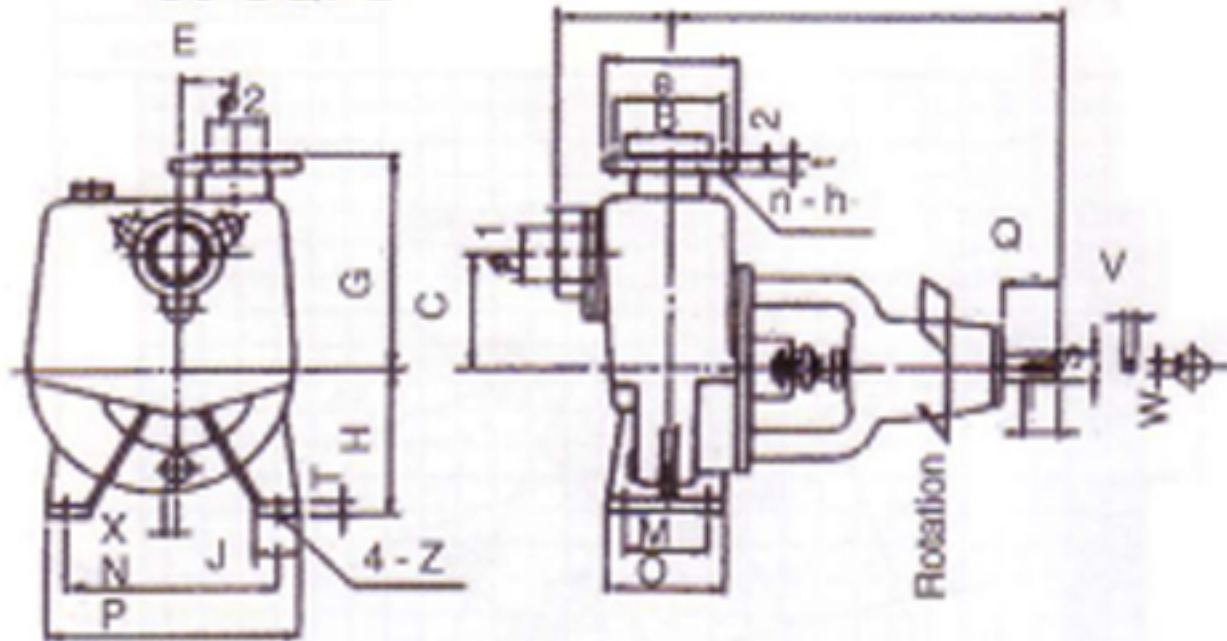

100 SQPB

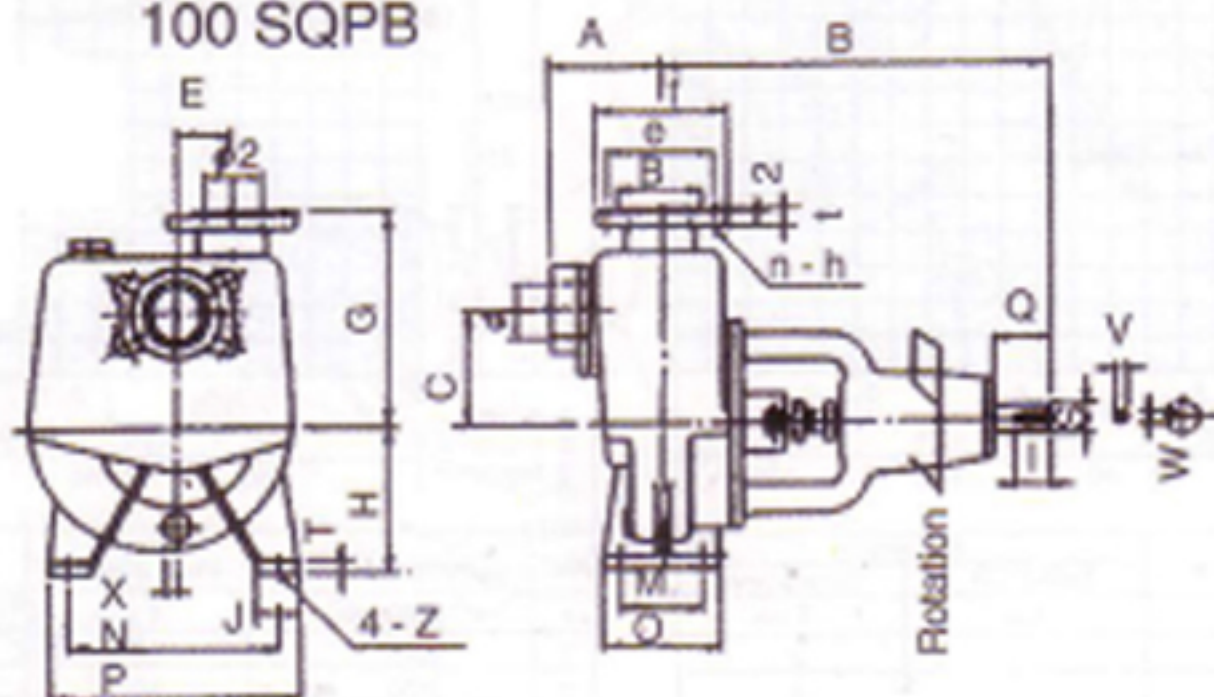

150 SQPB

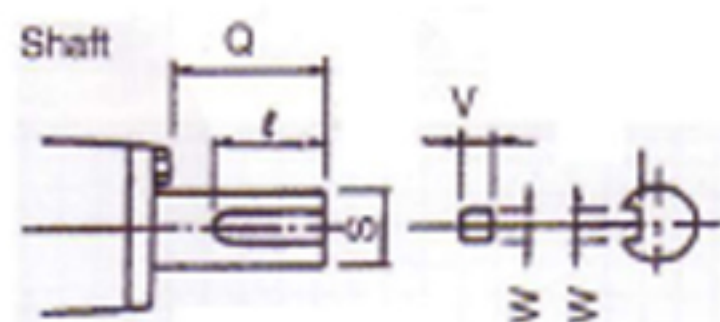
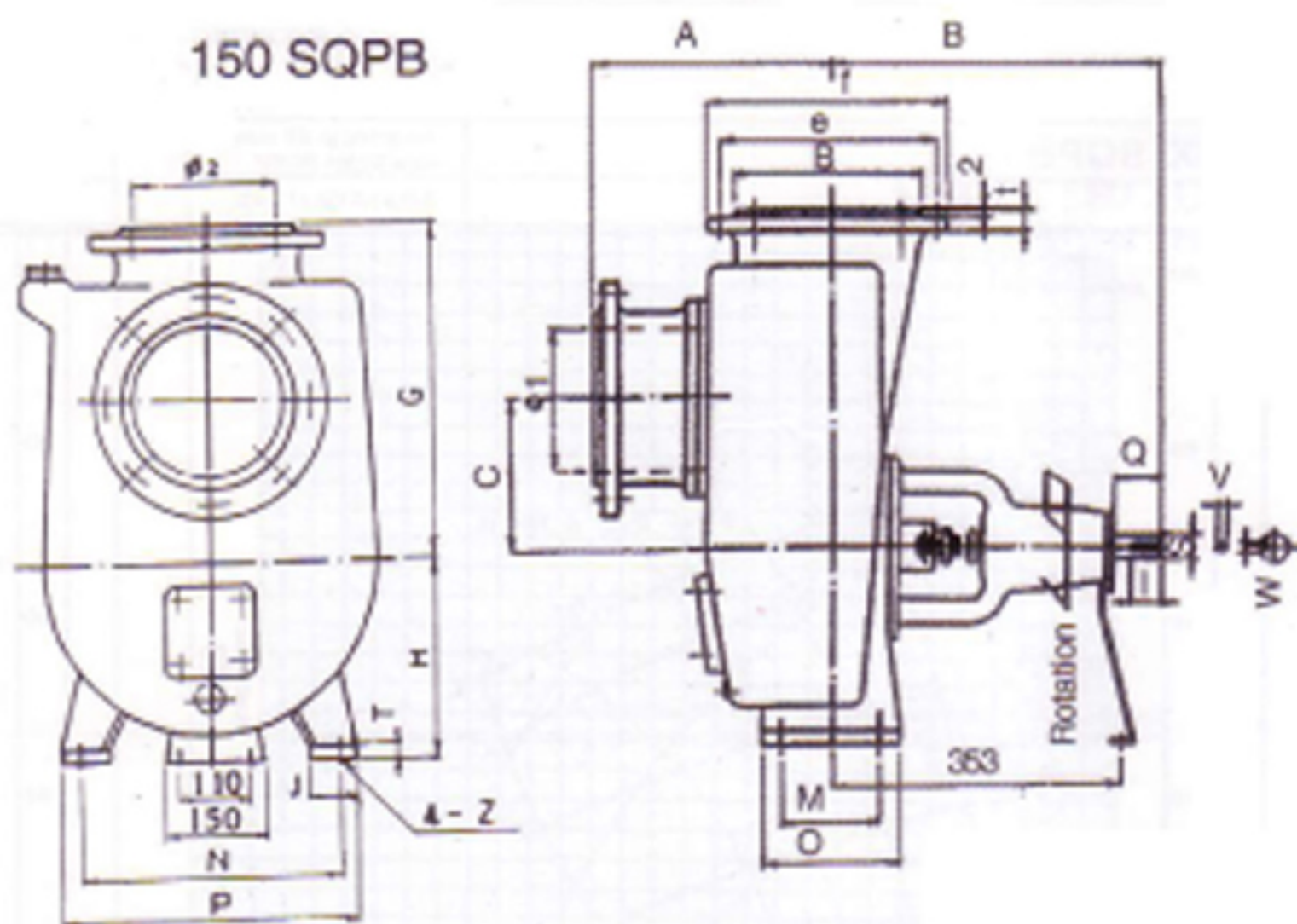

Unit:mm

MODEL	Ø2	g	e	f	t	n	h
50 SQPB	PS-2	-	-	-	-	-	-
80 SQPB	PS-3	130	150	185	18	4	15
100 SQPB	PS-4	155	175	210	20	4	15
150 SQPB	150	215	240	280	22	8	19

Unit:mm

MODEL	Pump															Shaft End					Weight (Mass) Kg
	Ø1	A	B	C	E	G	H	J	T	M	N	O	P	X	Z	S	Q	I	V	W	
50 SQPB	PS-2	100	240	100	40	165	112	35	10	50	150	80	180	0	12	19	34	27	6	6	17
80 SQPB	PS-3	120	275	120	25	225	132	40	12	70	190	100	230	10	12	24	50	40	8	7	27
100 SQPB	PS-4	130	330	155	25	275	160	50	12	100	230	140	280	20	15	28	55	50	8	7	42
150 SQPB	150	280	470	180	-	400	225	80	16	120	315	160	400	-	19	32	80	68	8	10	130

DISASSEMBLY

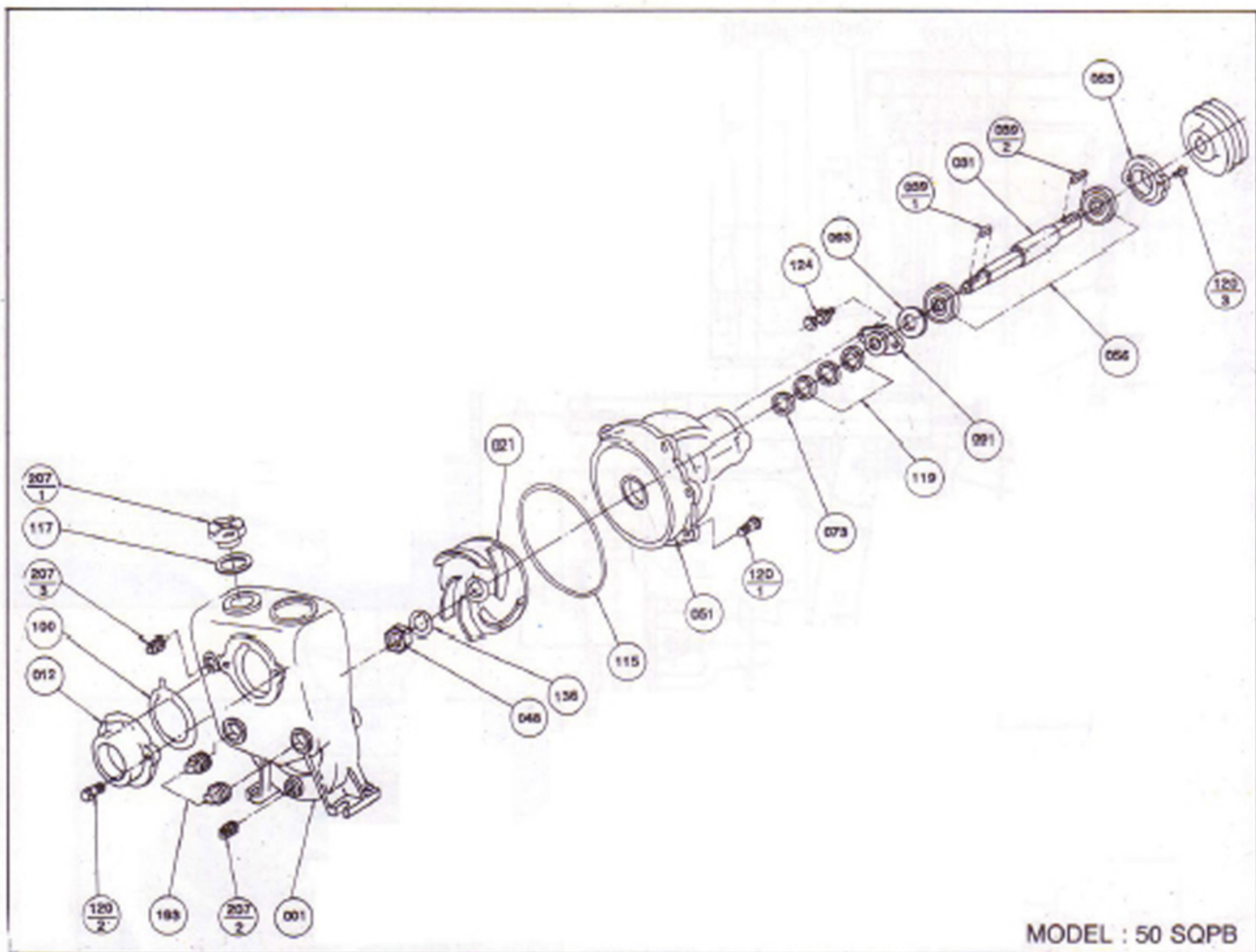

MODEL : 50 SQPB

All specifications are subject to change without notice



EBARA CORPORATION

Head Office, Tokyo
 International Division, Tokyo
 Singapore Office
 Beijing Office
 Bangkok Office
 Hanoi Office
 Jakarta Office
 Kuala Lumpur Office
 Manila Office
 Taipei Office
 Dubai Office

Phone : 81 - 3 - 3743 - 6111
 Phone : 81 - 3 - 5461 - 6111
 Phone : 65 - 862 - 3536
 Phone : 86 - 10 - 6590 - 8150
 Phone : 66 - 2 - 216 - 4935
 Phone : 84 - 4 - 826 - 3601
 Phone : 62 - 21 - 8740852
 Phone : 603 - 5569 - 1655
 Phone : 63 - 2 - 816 - 7524
 Phone : 886 - 2 - 567 - 1310
 Phone : 971 - 4 - 883 - 8889

Fax : 65 - 861 - 0589
 Fax : 86 - 10 - 6590 - 8158
 Fax : 66 - 2 - 216 - 4937
 Fax : 84 - 4 - 826 - 3617
 Fax : 62 - 21 - 8740033
 Fax : 603 - 5569 - 3766
 Fax : 63 - 2 - 817 - 6662
 Fax : 886 - 2 - 567 - 1046
 Fax : 971 - 4 - 883 - 5307

Distributor / Dealer



EBARA



ISO 9001 : 2000
Lk no. QCC2000



SELF PRIMING PUMP

FOR SEA WATER

MODEL **SQPB**



APPLICATIONS

- SHRIMP CULTIVATION
- FISH CULTIVATION
- MARINE , ETC

FEATURES

- Water mixed with a little sand or mud can be pumped up due to semi - open impeller design.
- Easy installation with engine for belt driven due to c.c.w rotation.

SPECIFICATION MODEL SQPB

DISCRIPTION	OPTION
Liquid	sea water
Temperature	0 - 40°C
Rotation	Counter clockwise when viewed from drive end
Material Casing Impeller Shaft	Bronze Bronze Stainless steel
Construction Impeller Stuffing box Bearing	Semi open Packing Sealed ball bearing

OTHER

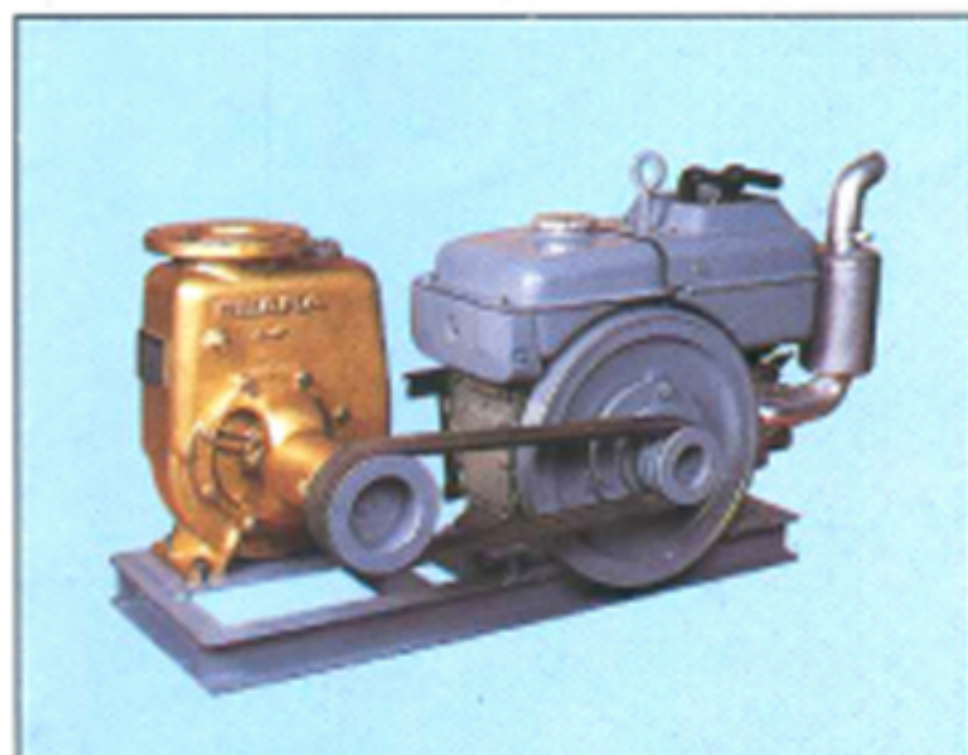

PUMP COULPED WITH ENGINE

- This picture doesn't show belt cover.
for safety belt cover should be install.



SEMI OPEN IMPELLER

BARE SHAFT PUMP DIMENSIONS

50 SQPB

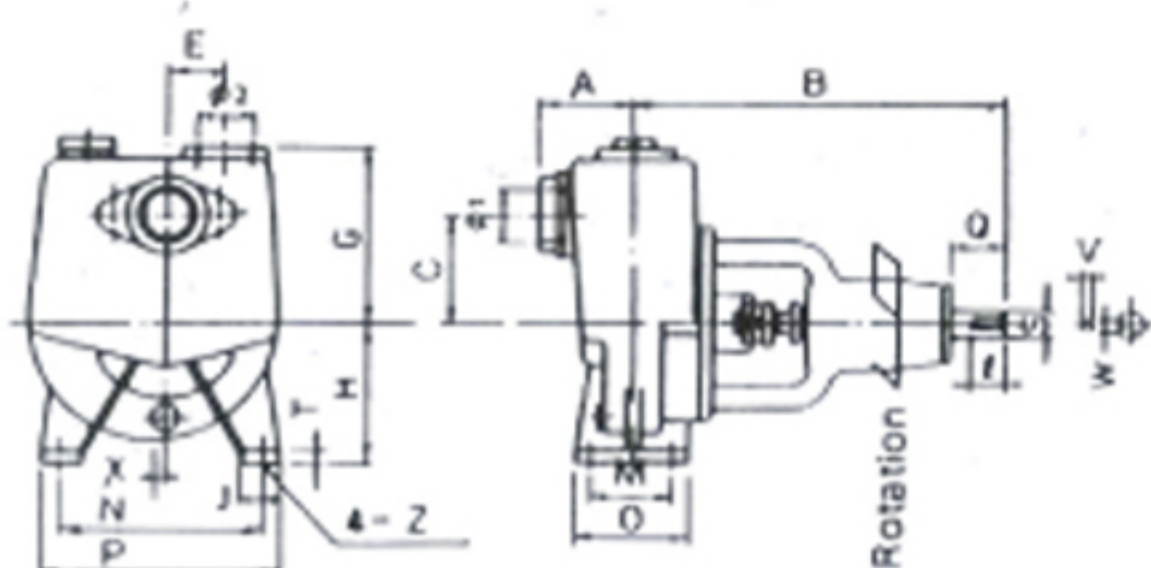

80 SQPB

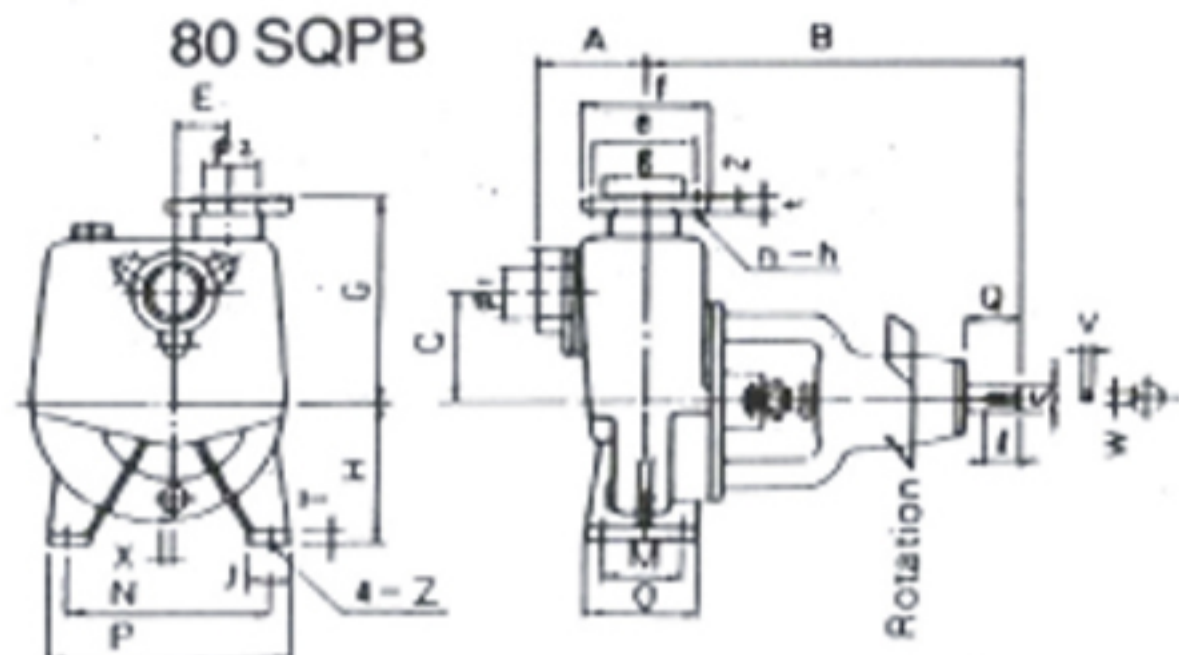

100 SQPB

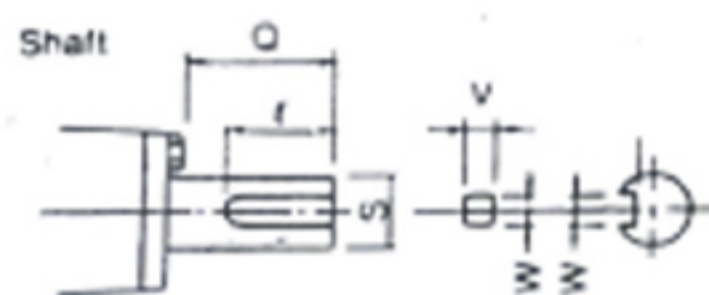
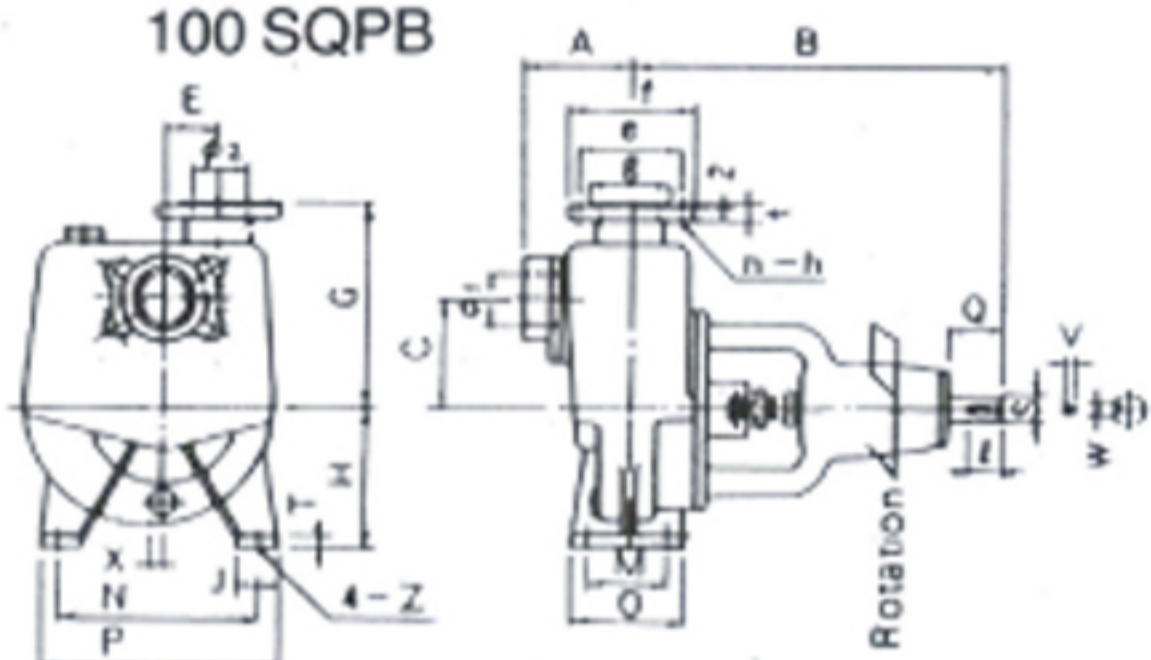

Unit:mm

MODEL	Ø2	g	e	f	t	n	h
50 SQPB	PS-2	-	-	-	-	-	-
80 SQPB	PS-3	130	150	185	18	4	15
100 SQPB	PS-4	155	175	210	20	4	15

Unit:mm

MODEL	Pump															Shaft End					Weight (Mass) kg
	Ø1	A	B	C	E	G	H	J	T	M	N	O	P	X	Z	S	Q	I	V	W	
50 SQPB	PS-2	100	240	100	40	165	112	35	10	50	150	80	180	0	12	19	34	27	6	6	21
80 SQPB	PS-3	120	275	120	25	225	132	40	12	70	190	100	230	10	12	24	50	40	8	7	38
100 SQPB	PS-4	130	330	155	25	275	160	50	12	100	230	140	280	20	15	28	55	50	8	7	61

PERFORMANCE CURVE

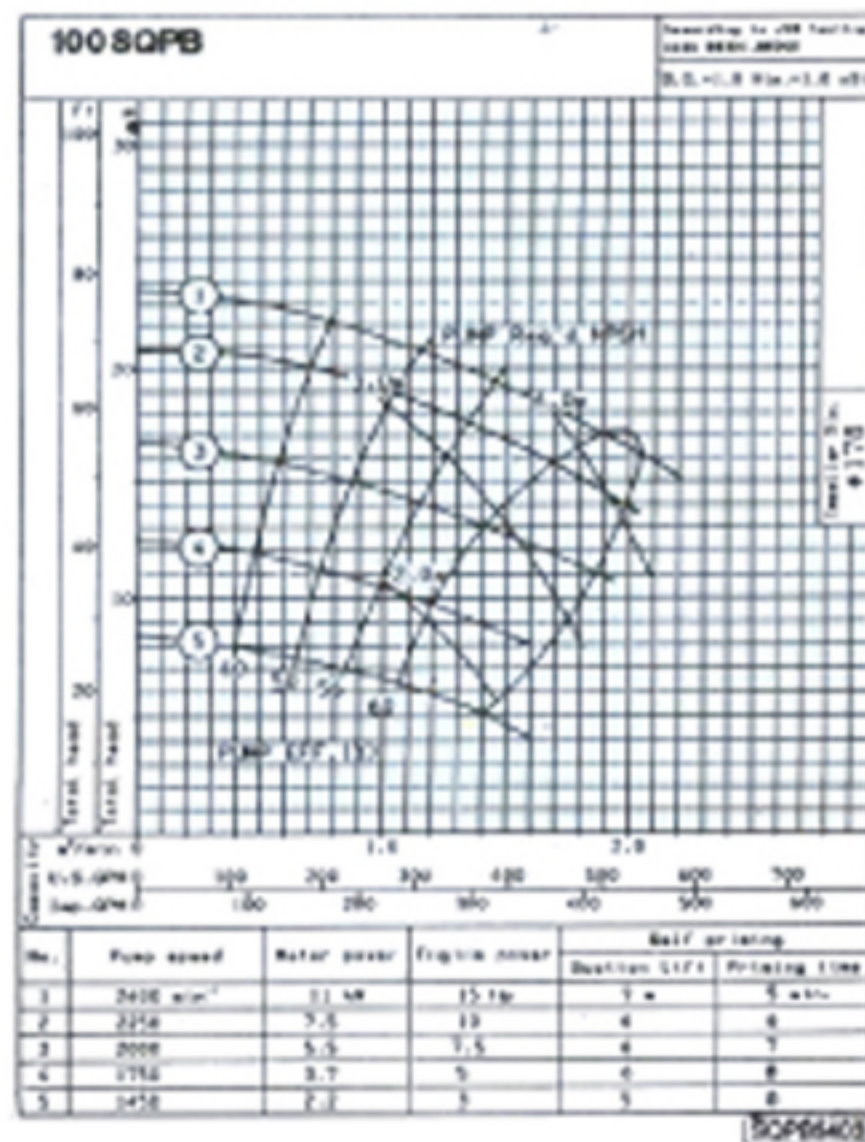
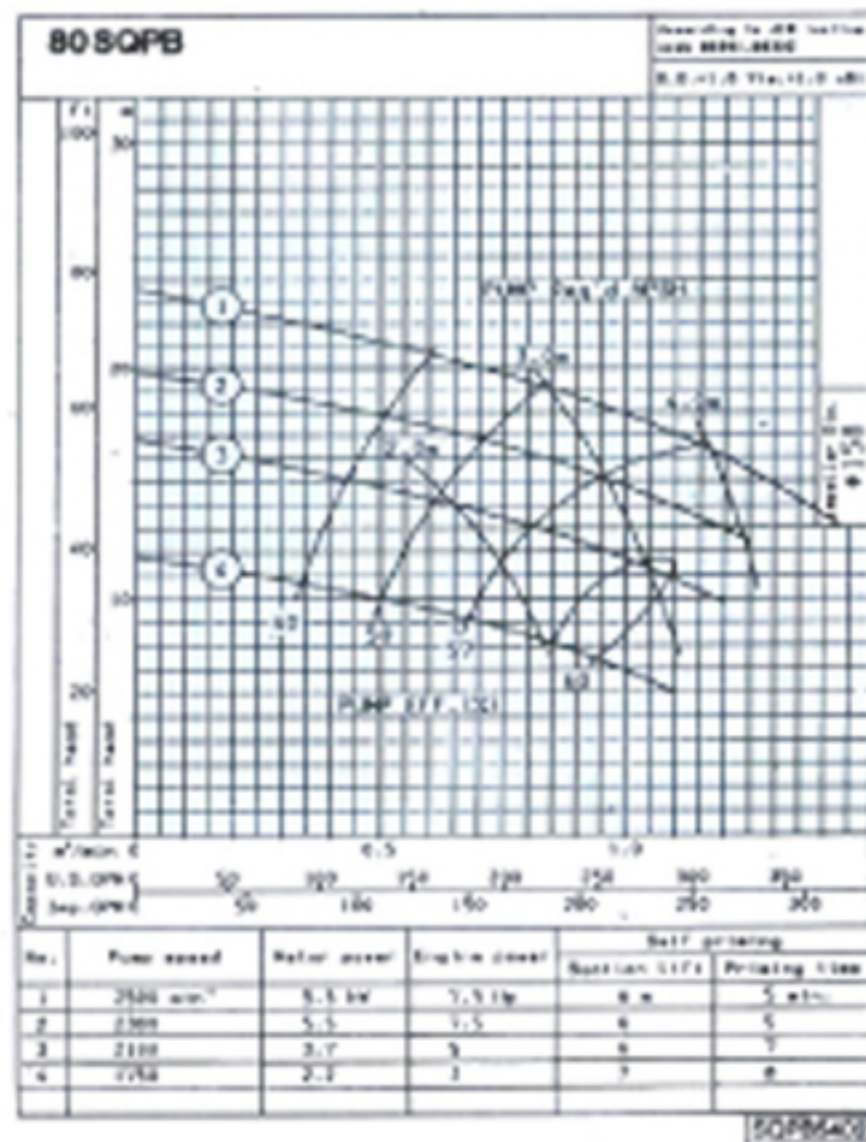
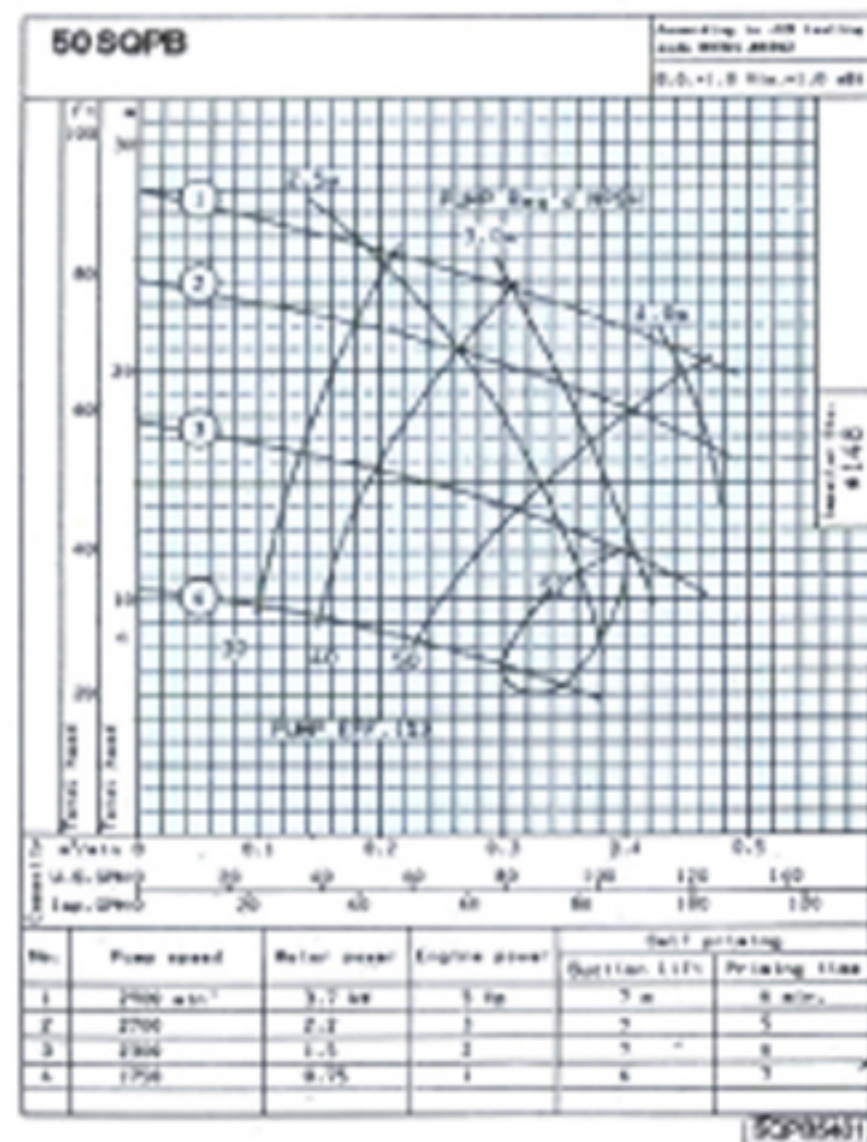

SECTIONAL VIEW

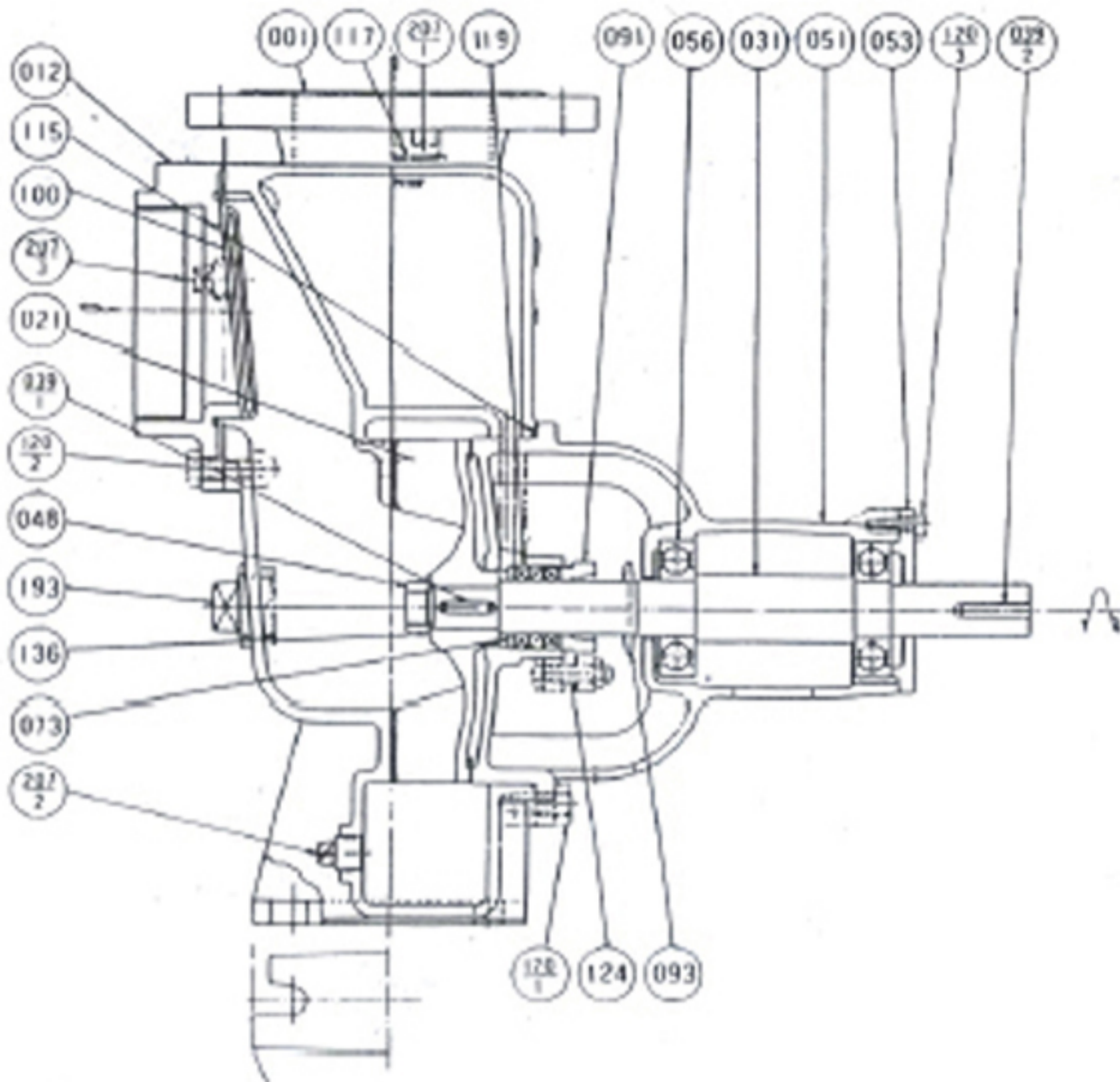

207-3	PLUG	BRONZE	1
207-2	DRAIN PLUG	BRONZE	1
207-1	PRIMING PLUG	PLASTIC	1
193	PLUG	BRONZE	2
136	WASHER	BRASS	1
124	GLAND BOLT AND NUT	STAINLESS STEEL	1
120-3	BOLT	STAINLESS STEEL	2
120-2	SUCTION COVER BOLT	STAINLESS STEEL	3
120-1	CASING BOLT	STAINLESS STEEL	4
119	GLAND PACKING	ASBESTOS	3
117	GASKET	RUBBER	1
115	O-RING	NBR	1
100	CHECK VALVE	RUBBER	1
093	DEFLECTOR	NBR	1
091	GLAND	BRONZE	1
073	STAGE PIECE	STAINLESS STEEL	1
056	BALL BEARING		2
053	BEARING COVER	BRONZE	1
051	BEARING HOUSING	BRONZE	1
048	IMPELLER NUT	BRASS	1
039-2	KEY	CARBON STEEL	1
039-1	KEY	STAINLESS STEEL	1
031	SHAFT	STAINLESS STEEL	1
021	IMPELLER	BRONZE	1
012	SUCTION COVER	BRONZE	1
001	CASING	BRONZE	1
PART NO	PART NAME	MATERIAL	NO. FOR 1 UNIT

All specifications are subject to change without notice



EBARA CORPORATION

Head Office, Tokyo	Phone: 81 - 3 - 3743 - 6111	
International Division, Tokyo	Phone: 81 - 3 - 5461 - 6111	
Singapore Office	Phone: 65 - 862 - 3536	Fax: 65 - 861 - 0589
Beijing Office	Phone: 86 - 10 - 6590 - 8150	Fax: 86 - 10 - 6590 - 8158
Bangkok Office	Phone: 66 - 2 - 216 - 4935	Fax: 66 - 2 - 216 - 4937
Hanoi Office	Phone: 84 - 4 - 826 - 3601	Fax: 84 - 4 - 826 - 3617
Jakarta Office	Phone: 62 - 21 - 8740852	Fax: 62 - 21 - 8740033
Kuala Lumpur Office	Phone: 603 - 5569 - 1655	Fax: 603 - 5569 - 3766
Manila Office	Phone: 63 - 2 - 816 - 7524	Fax: 63 - 2 - 817 - 6662
Taipei Office	Phone: 886 - 2 - 567 - 1310	Fax: 886 - 2 - 567 - 1046
Dubai Office	Phone: 971 - 4 - 883 - 8889	Fax: 971 - 4 - 883 - 5307

Distributor / Dealer